

AMO STANDARDS

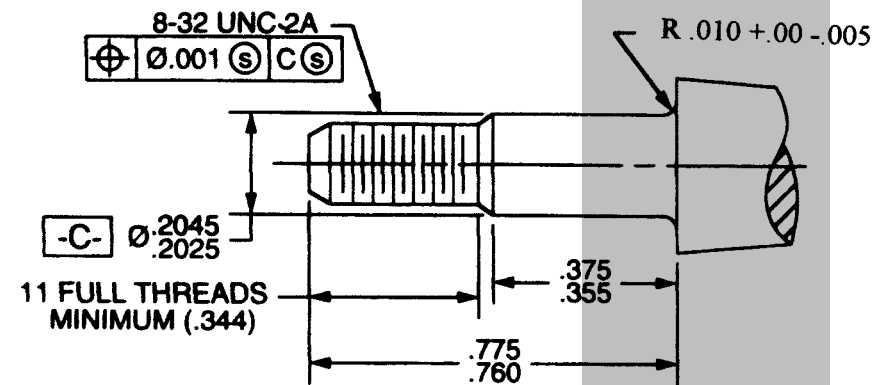

Published by:



ARCHERY MANUFACTURERS AND MERCHANTS ORGANIZATION

4131 NW 28TH LANE, #7
GAINESVILLE, FL 32606
(352) 377-8262 phone
www.amo-archery.org

revised 5/00

Prepared by:
AMO Standards Committee
Norb Mullaney, Chairman

AMO STANDARDS

In 1986 the AMO Board of Directors opted to have the AMO Standards Committee operate under the guidelines of the ASTM (American Society for Testing and Materials). The ASTM is a highly respected developer and provider of voluntary consensus standards, related technical information, and services having internationally recognized quality and applicability that promote public health and safety, and the overall quality of life; contributes to the reliability of materials, products, systems and services and facilitate national, regional, and international commerce.

Archery ASTM Standards are published under the jurisdiction of Sports Equipment F08.16. The following standards must be obtained directly from the ASTM located at:

**ASTM
100 Barr Harbor Drive
West Conshohocken, PA 19428.
Phone: 610-832-9485
Fax: 610-832-9555**

You can download directly from the internet by going to the ASTM web page. Their web address is: www.ASTM.org.

ASTM Standards are \$25.00 each.

The Archery ASTM Standards are:

Published standards under the jurisdiction of F08.16

F1352-91(1997)e1 *Standard Guide for Broadhead Performance and Safety Standards.*

F1363-91(1997)e1 *Standard Guide for Reduction of Risk of Injury for Archery Overdraws.*

F1435-94 *Standard Specification for Designation of the Balance Point Location for Archery Arrows.*

F1436-92(1997)e1 *Standard Guide for Center Serving Diameter Dimensions for Archery Bow Strings.*

F1544-99 *Standard Specification for Determining the Rating Velocity of an Archery Bow.*

F1648-95 *Standard Test Methods for Archery Bowstring Component-Serving String Material.*

F1752-96 *Standard Test Method for Archery Bow Component—Cord Material.*

F1753-96 *Standard Specification for Classification and Marking of Single-Lens Scopes for Use with Archery Bows.*

F1832-97 *Standard Test Method for Determining the Force-Draw and Let-Down Curves for Archery Bows.*

F1880-98 *Standard Test Method for the Determination of Percent of Let-Off for Archery Bows.*

F1889-98 *Standard Guide for Straightness Measurement of Arrow Shafts.*

AMO CONVENTIONAL BOW LENGTH STANDARD

AMO Bow Length Standard is designated to be three inches longer than AMO Bow String Master that braces bow at proper String or Brace Height. Bow String Master will carry only the bow length designation. Example: A Bow String Master designated as AMO 66" (bow length) will have an actual length under tension of 63".

Cable length is determined by placing loops over 1/4" diameter steel pins and stretching under 100 pound load and measuring from outside of pin to outside of pin. Tolerance is +1/16". End loops of cable will be 1 1/4" long and plastic coated.

Bow String Master shall have the following material specifications or equivalent: 1/16" 7 x 7 galvanized (Mil-C-1511) or stainless (Mil-C-5424) steel aircraft cable of 480 lb. test.

A Bow String Master Set shall consist of twenty-five Bow String Masters to measure bow lengths in one inch increments ranging from 48" to 72"; (i.e. actual string lengths 45" to 69").

The AMO prefix to bow lengths in inches means that the bow has been manufactured to a length that properly uses a bow string designated with the identical AMO marking. (i.e. A bow marked "AMO 60", 50 lb. will brace to the proper string height with a string marked "AMO 60", 45 lb. to 55 lb.)

AMO CONVENTIONAL BOW WEIGHT MARKING STANDARD

In accordance with the AMO Bow Weight Standard, the manufacturer has the option to mark his bow with actual draw weight at 28" (26 1/4" DLPP) draw or to use the following bow weight markings, especially on hunting models and middle, and low end bows.

Example:

- Bows weighing 19 - 20 -21 lb. - will be marked 20 lbs.
- Bows weighing 22 - 23 lbs. - will be marked 20X lbs.
- Bows weighing 24 - 25- 26 lbs. - will be marked 25 lbs.
- Bows weighing 27 - 28 lbs. - will be marked 25X lbs.
- Bows weighing 29 - 30 - 31 lbs. - will be marked 30 lbs.

All other conventional bow weights not shown would follow this same formula.

AMO STRING HEIGHT STANDARD

String, or brace, height is the perpendicular distance from the bow string to the Pivot Point of the bow handle (low point on the handle just below the arrow shelf, see nomenclature sketch, p.15) when bow is in strung condition.

Bows made to AMO Specifications should have string height indicated to a plus or minus 1/2 inch.

AMO BOWSTRING/CABLE LENGTH STANDARDS

Bowstring/cable length shall be designated by placing the string/cable loops over 1/4" (6.4mm) diameter steel pins. Zero (0) turns of twist are to be inserted in the bowstring/cable before tension loading. Flemish splice strings are exempt from twist limitations. Standard tension loads are listed below. Length measurements are to be taken from the outside of the top steel pin to the outside of the bottom steel pin after 20 seconds at load.

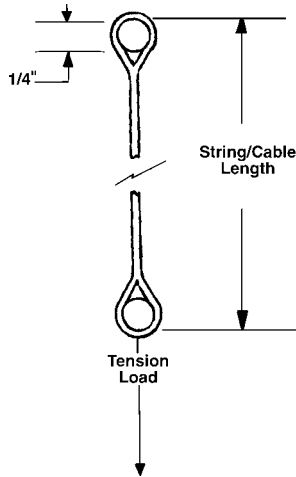

MEASURING TENSIONS

All 8 and 10 strand bowstrings made from polyester (i.e., Dacron) are to be measured under 50 +/- 1 pound (22.68 kilograms) of tension load. All other strings and cables for compound and non compound bows are to be measured under 100 +/- 1 pound (45.4 kilograms) of tension load.

Compound and non-compound bowstring lengths will be within a tolerance of +/- 1/8" (3.2 mm) when measured under tension load. Compound cables (harness) will be within a tolerance of +/- 1/16" (1.6mm) when measured under tension load.

Tension loads and tolerances are AMO standards, however, bow manufacturer may specify otherwise.

AMO COMPOUND BOW STRING LENGTH STANDARD

Compound bowstring length shall be designated by its stretched length as determined by placing the string loops over 1/4" diameter steel pins and stretching with 100 lbs. of tension. Measurement is taken from outside of pin to outside of pin. Tolerance is +/- 1/4" after 20 seconds under tension load.

EXPLANATION: Compound bowstring lengths have no particular relationship to bow length and therefore actual string length under load is used for length designation.

BOW MARKING

AMO Compound Bowstring Length _____

AMO Compound Cable Length _____

"OR"

AMO Non-Compound Bowstring Length _____

STRING PACKAGE MARKING

String Material _____

Number of Strands _____

AMO Compound Bowstring Length Under Tension _____

AMO Compound Cable Length Under Tension _____

"OR"

AMO Non-Compound Bowstring Length Under Tension _____

NOTE: When an "AMO Non-Compound Bowstring Length" is not shown on a bow, the appropriate string length will be 3 inches shorter than the bow length designation.

HOW TO USE THESE SPINE SELECTION CHARTS

Draw Length is the distance, at archer's full draw, from nocking point on string to the pivot point of the grip plus 1 3/4 inches. For standardization purposes, all bows are weighed and marked at 28" draw length. To determine bow weight of a conventional bow at draw length longer or shorter than 28" use the draw weight correction factor of 20 in the following formula: Bow weight at 28" divided by 20 and multiplied by the number of inches draw length differs from 28". Subtract or add this amount to the bow weight at 28", depending on whether or not draw length is shorter or longer than 28".

Examples:

1) Bow Weight = 42 lbs, Draw length = 25 1/2"

$$42 \text{ lbs} \div 20 = 2.1 \text{ lbs} \times 2.5" = 5.25 \text{ lbs}$$

$$42 \text{ lbs} - 5.25 \text{ lbs} = 36.75 \text{ lbs at } 25 \text{ 1/2" draw length.}$$

2) Bow Weight = 38 lbs, Draw Length = 30"

$$38 \text{ lbs} \div 20 = 1.9 \text{ lbs} \times 2 = 3.8 \text{ lbs.} + 38 \text{ lbs.}$$

$$= 41.8 \text{ lbs at } 30" \text{ draw length}$$

Note: The spine recommendations shown here serve as a basic guide for wood arrow spine determination. The best spine for a particular need may not always correspond with the charts.

AMO WOOD ARROW SPINE DEFLECTION VALUES

| + DEFLECTION | * |
|--------------|---|
| 1.20 to 1.00 | A |
| 1.00 to .85 | B |
| .85 to .75 | C |
| .75 to .65 | D |
| .65 to .58 | E |
| .58 to .52 | F |
| .52 to .47 | G |
| .47 to .43 | H |
| .43 to .40 | I |
| .40 to .37 | J |
| .37 to .35 | K |

+ Deflection is measured in inches with shaft supported on 26" centers and depressed with a two-pound weight.

* AMO spine symbol designation.

AMO WOOD ARROW SPINE SELECTION CHARTS

TARGET ARROWS

| BOW WT. AT DRAW WT. | *Arrow Length | | | | | | | | | |
|---------------------------|---------------|----|----|----|----|----|----|----|----|--|
| | 24 | 25 | 26 | 27 | 28 | 29 | 30 | 31 | 32 | |
| 20-25 | A | A | A | A | A | B | B | C | D | |
| 25-30 | A | A | A | A | B | C | D | D | E | |
| 30-35 | A | A | A | B | C | D | E | E | F | |
| 35-40 | A | A | B | C | D | E | F | G | H | |
| 40-45 | A | B | C | D | E | F | G | H | I | |
| 45-50 | B | C | D | E | F | G | H | I | J | |
| 50-55 | C | D | E | F | G | H | I | J | K | |
| 55-60 | D | E | F | G | H | I | J | K | | |
| 60-65 | D | E | G | H | I | J | K | | | |
| 65-70 | E | F | G | I | J | K | | | | |

* For all practical purposes, arrow length and draw length may be considered the same.

FIELD & HUNTING ARROWS

| BOW WT. AT DRAW WT. | *Arrow Length | | | | | | | | | |
|---------------------------|---------------|----|----|----|----|----|----|----|----|--|
| | 24 | 25 | 26 | 27 | 28 | 29 | 30 | 31 | 32 | |
| 20-25 | A | A | A | A | B | B | C | D | E | |
| 25-30 | A | A | A | B | C | D | D | E | F | |
| 30-35 | A | A | B | C | D | E | E | F | G | |
| 35-40 | A | B | C | D | E | F | G | H | I | |
| 40-45 | B | C | D | E | F | G | H | I | J | |
| 45-50 | C | D | E | F | G | H | I | J | K | |
| 50-55 | D | E | F | G | H | I | J | K | | |
| 55-60 | E | F | G | H | I | J | K | | | |
| 60-65 | E | G | H | I | J | K | | | | |
| 65-70 | F | G | I | J | K | | | | | |

* For all practical purposes, arrow length and draw length may be considered the same.

AMO BOW SIGHT & ACCESSORY MOUNTING HOLES STANDARD

Two holes located on the outside of the bow window are to be 10-24 threaded holes spaced 1.312 +/- .010 center to center. Minimum thread depth shall be .250. Mounting holes in sights or other side mounting accessories should conform to these dimensions. A line through the axis of the holes shall be parallel to the bowstring.

EXPLANATION: 10-24 threaded holes are used to provide a secure fastening for bow quivers, fishing reels, etc.

AMO STABILIZER & ACCESSORY MOUNTING HOLE STANDARD

All threaded holes or inserts (other than the AMO Bow Sight and Accessory Mounting Holes Standard) that are used to mount stabilizers weights, or accessory items (such as bow quivers, fish reels, etc.) shall be 5/16" - 24 threaded holes. Minimum thread depth shall be 9/16".

EXPLANATION: The 5/16" - 24 threaded holes proved an adequate margin of strength needed to cope with the greater stress loads imposed by the compound bow, heavier and longer stabilizers and kevlar bowstrings. The 9/16" minimum thread length is compatible with the maximum stud length of the stabilizer. This limitation is imposed for the express purpose of limiting the hole depth to minimize the weakening effect of holes in the handle castings.

AMO STABILIZER ROD STANDARD

The Stabilizer stud that mates with the stabilizer mounting hole (base end) shall be 5/16" - 24 thread with a length of 1/2" +/- 1/16". the stud to which the stabilizer weight attaches (outer end) shall be 1/4" - 20 thread with a length of 3/8" +/- 1/16".

EXPLANATION: The base end stud is a limited in length to assure mating with depth of mounting hole. The stud at outboard end is limited to a shorter, but adequate, length to accommodate the dimensionally small weighting elements. Also, the 1/4" - 20 thread at the weight end is quite adequate considering the relatively low load factor.

AMO DRAW LENGTH STANDARD

For Manufacturers

Draw length is a specified distance, or the distance at the archer's full draw, from the nocking point on the string to the pivot point of the bow grip (or the theoretical vertical projection of a tangency line to the pivot point parallel to the string) plus 1 3/4". Draw length from pivot point shall be designed at DLPP and shall be called TRUE DRAW LENGTH.

EXAMPLE: 26 1/4" DLPP plus 1 3/4" is the equivalent of 28" draw.

For Dealers and General Use

For practical reasons not requiring precise terms, draw length is the distance, at the archer's full draw, from the nocking point on the string to the back of the bow at the arrow rest.

EXPLANATION: The standard Manufacturers is consistent with the Bow Weight Standard as related to the pivot point. The DLPP plus 1 3/4" is compatible to previous concepts of draw length. (See handle illustration.) Draw length for Dealers and General Use relieves the burden of preciseness not required for general use and facilitates determining arrow length. THIS STANDARD SUPERSEDES THE PREVIOUS STANDARD.

AMO BOW WEIGHT STANDARD

For Conventional Bows

Bow weight is the force required to draw the nocking point of the bow string a given distance from the pivot point of the bow grip (or the theoretical vertical projection of a tangency line to the pivot point parallel to the string). Draw length from pivot point shall be designated as DLPP and shall be referred to as TRUE DRAW LENGTH.

For the purpose of uniform bow weight designation, bow weight is the force required to draw the bow string 26 1/4" from the pivot point. This weight will be marked on bow as being taken at 28" draw (26 1/4" plus 1 3/4" = 28") See DRAW LENGTH STANDARD.

EXAMPLE: **Weight Adjustment Range:** 45/55 lbs.
Weight Set At: 50 lbs.; Hold 32 lbs.
Draw Length Range: 29" - 30"

EXPLANATION: The pivot point is a more realistic measuring point (when compared to the variations of profile of the back of bows at the handle section) for establishing bow weight since the pivot point is a constant in all bows as well

as the contact point of the bow hand from which the true draw length is generated. The 26 1/4" DLPP is the approximate equivalent of the 28" draw used previously on the more massive wooden handle bows.

AMO BROADHEAD & FIELD ARROW FLETCHING RECOMMENDATION

1. Fletching for three vane arrows
 - a) Length 5" minimum
 - b) Square inches 1.9 minimum
 - c) Height 5/8" maximum
2. Fletching for four vane arrows
 - a) Length 4" minimum
 - b) Square inches 1.4 minimum
 - c) Height 5/8" maximum
3. Fletching shall be spiraled with the limits of one revolution in 2 1/2 feet to one revolution in 6 feet.
4. Compliance with other AMO arrow standards, such as arrow length, tapers, adapters, etc.

EXPLANATION: Accurate broadhead flight requires adequate fletching for true guidance. The combined dimensions of length and height plus area size assures a vane configuration sufficient to stabilize arrow flight and minimize vane flutter. True spiral fletching (helical) is recommended for hunting arrows rather than diagonal (or straight) fletching. Diagonal fletching is limited by arrow shaft diameter as to the amount of rotation it can produce, resulting in limited guidance effect. Excessive spiral (less than 2 1/2 feet per revolution) creates excessive drag (deceleration), wind drift and vane noise. The term "Field Arrow" is a broad term which, considering the almost universal use of the interchangeable point system, becomes synonymous with the broadhead arrow and therefore requires the same specifications.

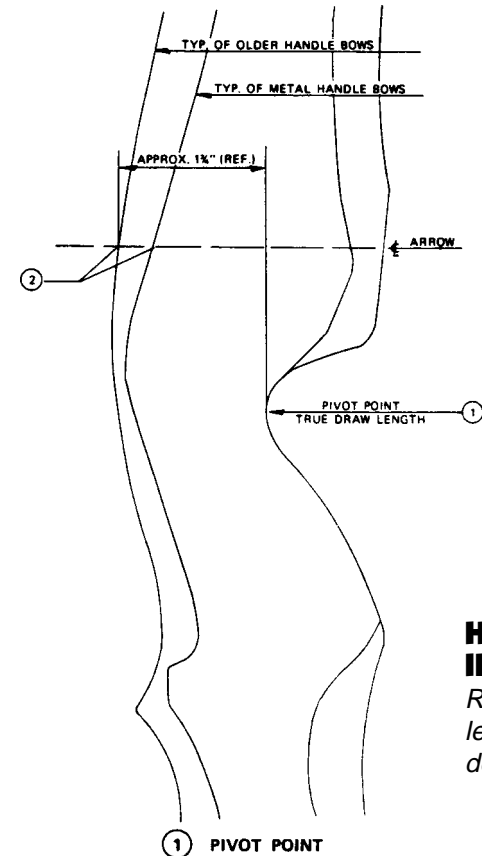

HANDLE ILLUSTRATION
Reference for draw length and bow weight determination

PIVOT POINT ①

The point at which True Draw Length and Manufacturer's Draw Length and Draw Weight are determined.

True Draw Length is the Draw Length from Pivot Point and is designated as DLPP.

AMO Draw Length is the distance to Pivot Point plus 1 3/4". This establishes a constant when compared to the variations of profile of the back of bows. Thus - 26 1/4" from Pivot Point is equivalent to 28" draw length and is the draw length at which manufacturers weight and mark conventional bows.

AMO ARROW LENGTH STANDARDS

AMO Arrow Length—the length dimension from the bottom of the nock slot forward to the designated point near the front or leading end of the arrow assembly. The designated point varies to accommodate the different designs because of the differences in arrow point design and attachment.

1. For arrows incorporating interchangeable point system inserts and other point or adapter types that insert into the open forward end of the arrow shaft, the designated point is the front end of the arrow shaft, often referred to the "cut length" (Fig 1, p.13).
2. For arrows having the front end of the shaft tapered or swaged, the designated point is the most forward extension of the full diameter of the shaft (Fig 2, p.13).
3. For arrows incorporating outserts, the designated point is 3/4 in. (19mm) forward of the rearward end of the outsert (Fig 3, p.13).
4. For arrows using heads that have integral cylindrical sockets incorporated within the basic head configuration, the designated point is the rearward end of the socket (Fig 4, p.13).

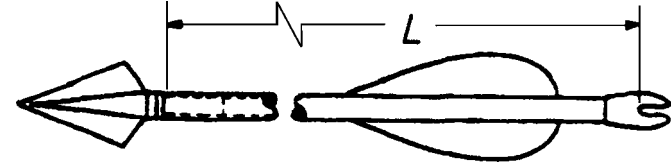

FIG 1. Arrow Assembly Employing an Interchangeable Point Insert.

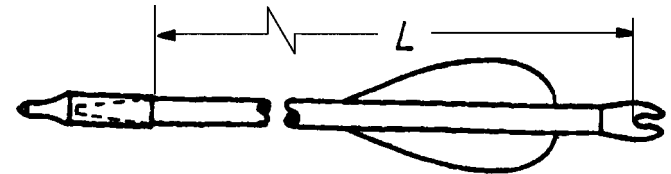

FIG 2. Arrow Assembly Having the Front End of the Shaft Tapered or Swaged.

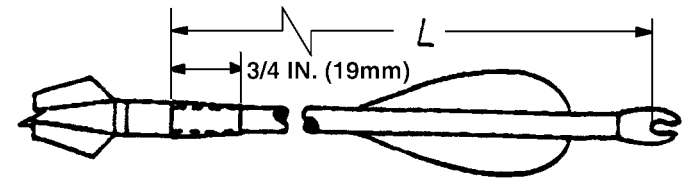

FIG 3. Arrow Assembly Incorporating an Outsert.

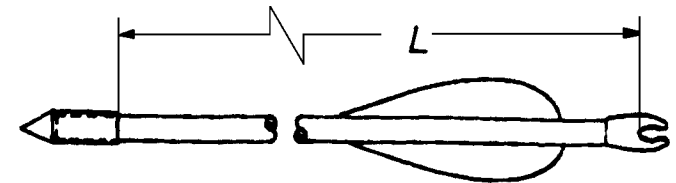
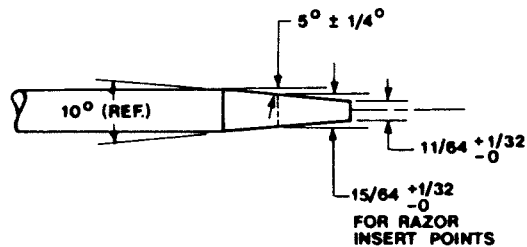
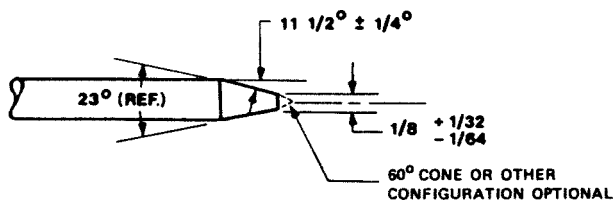

FIG 4. Arrow Assembly With a Head That Has an Integral Cylindrical Socket.

AMO 5° TAPER ARROW POINT STANDARD



AMO ARROW NOCK TAPER STANDARD



AMO INTERCHANGEABLE POINT SYSTEM STANDARD

SHAFT INSERT

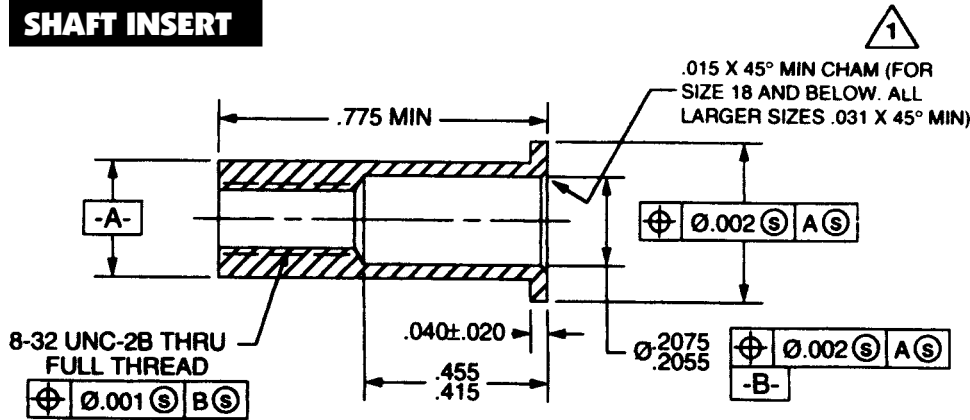

BROADHEAD ADAPTER & POINT SHANK

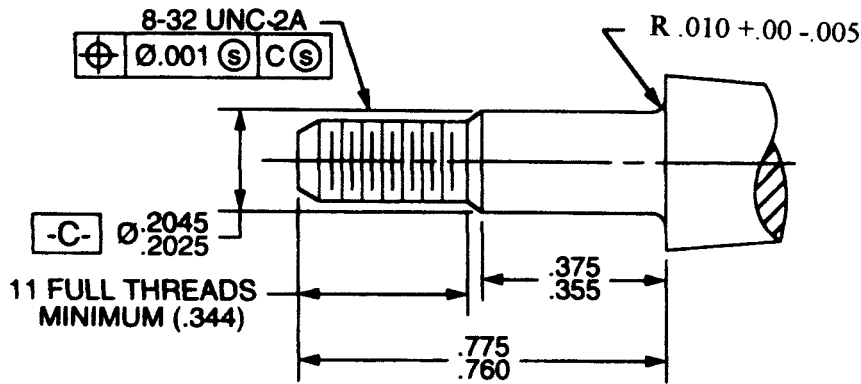

BROADHEAD ADAPTER

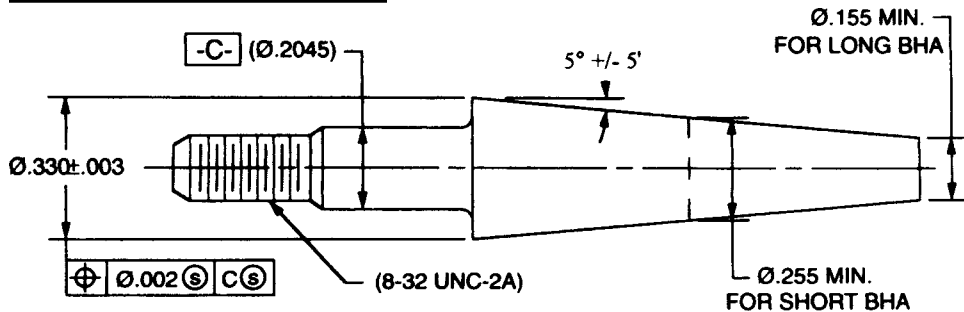

AMO BOW AND ARROW NOMENCLATURE

In February 1968, The Archery Manufacturers Organization officially adopted these AMO Manufacturing Standards for Bows, Bow Strings and Wood Arrows.

As part of this program, the nomenclature, or words to describe, the many parts of a bow and arrow were agreed on. Archers, dealers and the public have been confused by the industry's use of interchangeable words (i.e. Fistmele and String Height). By using common simple terms this confusion will be lessened.

These diagrams illustrate the Standard Nomenclature as approved by the Archery Manufacturers and Merchants Organization and recommended by the American Archery Council.

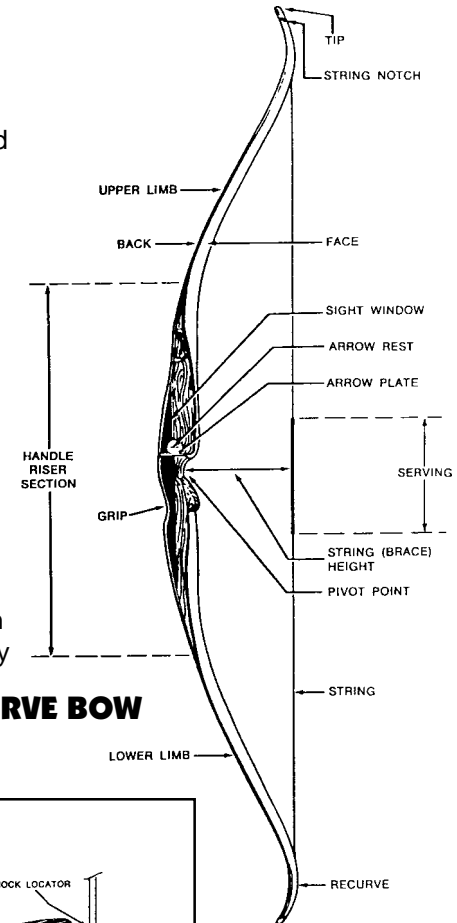

RECURVE BOW

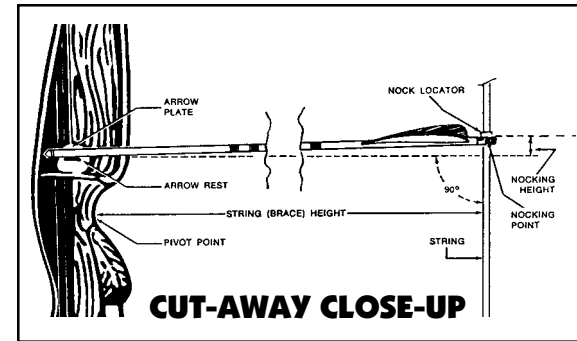

CUT-AWAY CLOSE-UP

